

## Protection of Distance for Groups of Decentralized Productions Connected in HVB Network

D. Labeled, M. Zellagui, M. Bouchehdane and A Bouzid

Laboratory of Electrical Engineering, Faculty of Science and Engineering,  
University Mentouri Constantine, Algeria

**Abstract:** In this study, our aim is to study the reason of competition of two protections of distance equipped each one with its own reeclenchor in order to supervise a decentralized production connected out of antenna to a HVB line; this is dictated by an increasingly large need to reduce undistributed energy; stage with rare failures, as for the existing continuity of the network because of the considerable economy that represents.

**Key words:** Decentralized production, connection with HVB network, protection of distance, numerical relay of distance, SIPROTEC 7SA612

### INTRODUCTION

Each work of HVB (High Voltage class B) network lays out protections comprising its own clean sound protection system. The plans of protection coordinate the whole of these systems.

They are based on the three following guiding principles:

- Each work of the network has its own protection system independent of that of the others.
- The protection system of a work must act as help (known as "distant"), at least partially, in the event of failure of the protection system of another work (safety of the people and the goods).
- The protection system of each work comprises several independent protections, in particular when the distant help is dubious. The actions of these protections are the subject of a precise logic taking of account the level of necessary reliability and the requirements speed-selectivity.

They specify the normative needs to satisfy (performances) as regards:

- Speed of elimination.
- Selectivity.
- Safety with respect to the people and the goods.

In addition, in situation of unavailability, they specify the level of expected performance waited (for example in

the event of failure of a principal protection, or a switchgear): The need concerns the reliability.

One of the significant aspects is obviously, the performance in time of elimination; this one is determined, primarily, with the examination of the 3 following points:

- Guarantee of the production groups stability centralized with particular requirements for the nuclear sites (250 ms with failure).
- Guaranteed level of supply quality of to the customers (currently, certain hollows of tension are the subject of compensation for durations higher than 600 ms).
- Guarantee of behaviour of the materials: HVB networks (held of the sheaths of the buried cables, cables of ground network of the stations, transformers feeding of the external defects...), other networks (in particular of the telecommunications networks).

### THE PROBLEMATIC OF THE HVB NETWORKS PROTECTION

The groups of Decentralized Production connected in HVB (networks 63 - 90 and 225 kV) take part, when they are started, in the supply of the defects affecting the works of connection (lines, buried cables, stations) (Labeled, 2006). It belongs to:

- The Owner of the Network to define the expression of its needs as a person in charge for the exploitation for networks HVB,
- The Producer to satisfy these needs by the implementation for the adequate means as a person in charge for the disturbances (supply of the defects of insulation) affecting HVB networks of connection.

**Expression of the needs:** The expression of the needs is established on the basis of Plan of Protection of the concerned networks (225 kV or HVB) and according to the mode of connection which is determining (nature of the level of tension, nature of the works air lines, connections underground, direct connection on the sets of bars of a station...). It requires the realization of an inventory of fixtures as regards:

- Protection systems of the various works of the network concerned and associated performances.
- Level of supply quality of (in term of long, short, very short cuts, of hollow of voltage and disturbances and pollution of the wave of voltage) in particular object of contractualisation with customers served by the station of connection or the framing stations.

It rests on the principle that the connection of the means of decentralized production should not degrade the performances of operation of HVB networks and the quality of supply to the customers and must allow their similar improvement in time that there would be in its absence.

It must comprise, in the respect of the protection plan, the following needs as regards performances for the protection system to be implemented by the producer:

**Speed of elimination:** Maximum Times of elimination of the defects on the links of connection to the GFS (General Feeder System) and on the bars of the station of connection to the GFS.

**Selectivity:** Emission by the protection system of one is tripping order of the only circuit breakers delimiting the work at fault.

- Identification of the works and the concerned switchgear.
- In the case of connection by an air line with 225 kV, elimination in the event of defect single-phase current not or not very resistant per opening only phase at fault (this provision being systematically carried out on the network 225 kV of the GFS).

This need is based on the research of the best availability as regards evacuation of energy insofar as the producer accepts it and where the group admits it technically (stability).

- Possibly, a minimal time of elimination of the defects on the links of connection to the GFS or on the bars of the station of connection to the GFS in certain particular situations.

**Safety of the people and the goods:** Standard ISO 8402, risk of physical injuries limited to an acceptable level.

- Existence, within the protection system, of equipment ensuring a help "distant" allowing elimination from a defect affecting another work that the connection work, in an acceptable time in the event of failure and whatever is its origin (resistant defect, damages reducing of measurement, defect of common mode...).

**Reliability:** Doubly of selective principal protections except absence of need (a very weak probability of defects on the link of connection like the guarantee of ensuring a preventive maintenance of high quality constituting the significant elements not to resort to it). This applies to connections in 225 kV or 63-90 kV in certain cases (stations F and certain stations S on high level of quality).

Treatment of the failure circuit breaker (with the opening requested by a protection) in the case of a direct connection on a HVB station of the GFS (without link of connection equipped with circuit breakers). It is about the taking into account by the Producer of an action of instantaneous decoupling of its installations, following detection by the owner of the Network of the failure of one of the switchgear of its station (on the assumption that this station is equipped with the function "failure circuit breaker").

## **THE MEANS COMPRISING THE PROTECTION SYSTEM**

On the basis of the needs (performances and guarantees) defined by the owner for the network, the producer is responsible for the choice of the materials constituting the protection system of HVB network to be installed at his place. He is as completely responsible for operation, whether it is good or bad, of all his installations thus of the protection system satisfying the needs expressed explicitly by the owner for the Network.

In the continuation of this article, the materials of protection of the HVB networks are described to which generally recourse has the companies of electricity to equip its works, while insisting on the protection of distance. They appear in the plane document of doctrines of protection of the Networks and it is necessary to regard this list as a recommendation.

In addition, the definition of the reducers of measurements (running and voltage) must be the attentive examination objects (choice of the nominal mode, classification and power of precision...) and concerted, taking into account the transitory behaviours (contributions  $I_{cc}$ ...) of the stations generating and of HVB network. This dialogue results in the exchange of the transitory electric characteristics of the works alternator, transformer of evacuation, lines, cables and stations of the network.

### Principal protections

**The protection of distance:** It is the type of protection generally used on HVB networks of the air type. Requiring only measurements (current and voltage of phase) local and having a device of anti pumping (not to be sensitive to the situations of oscillations of power), it constitutes a powerful means in term of speed and selectivity for the elimination of the defects line and bars of connection station. Its operating time is in theory compatible with times of elimination (time of opening circuit breakers included) belonging to ranges 250-500 ms (in 225 kV) and 250-850 ms (in 63-90 kV) usually necessary (Lebed, 2006b). Finally, it can ensure a "distant" help under good conditions. Current numerical technology enables them to have interesting complementary functions (not very active source, perturbography...).

**Differential protection:** It is the second type of protection used on the networks. Requiring measurements of the currents at the two ends of HVB connections, it is slightly deployed on the air lines but very mainly used on the underground connections, the cables pilots-TCM ensuring the support of transmission for information to exchange between the 2 ends under excellent conditions. On the other hand, they do not offer any "distant" help and must be supplemented protections for the elimination of the defects bars according to the needs to satisfy.

**Protections of help:** This equipment is characterized by their simplicity which confers them a guarantee of availability on the detriment of performances as regards selectivity thus of speed. Are usually employed the following protections:

- Protection with minimum of HVB network. It is tolerated, in certain situations of connection, to feed them in voltage side groups.
- Homopolar protection of current (with minimum) of neutral HVB of the transformer of evacuation of the groups.
- Protection of antenna passivity (mixed protection) to guarantee the realization of cycle single-phase current in situation of group to the stop, on the link of connection in 225 kV (case of connection to mixed vocation producing connection and customer). This protection can be considered, according to the adjustment of temporizations selected, like a principal protection in that case.

### PROTECTION OF DISTANCE

This protection is the most used equipment in world on all HVB networks of the air type, (particularly because of its total autonomy which does not require any connection between two ends of the line to be protected), it is characterized by two characters:

- The relation between the distance from the defect and the time of release of the relay.
- The electric quantities which make it possible to measure the distance from defect.

Remote protection is selective, insensitive with external defects, operation except synchronism of the network and with the variations of the tension; it can be used on lines of which the length is included/understood between 10 and 300 km and of the voltage of service higher than 30 kV (Samantaray *et al.*, 2005).

These protections using the elaborate local criteria starting from the measurement of the currents and/or tensions on the level of each departure (El-Arroudi *et al.*, 2002). In fact protections of distance make it possible to locate the site of the defect by measurement of the impedance ranging between the reducers of the departure measurement which deliver the electric quantities of reference and the point of defect.

The principle of the protection of distance is based on the Ohm' law,

$$\text{Knowing that: } U = Z_L * I \text{ with } Z_L = R_L + jX_L$$

With the case of defect; current  $I$  increases, the tension  $U$  decreases with the result that the impedance of line  $Z_L$  varies.

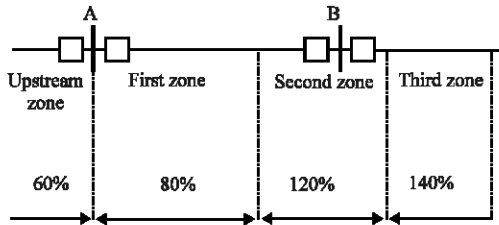

Fig. 1: Zones of the protection of distance.

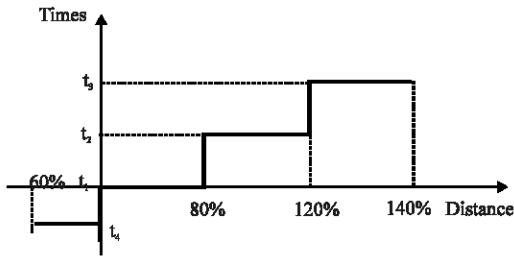

Fig. 2: Chronometric selectivity of the protection of distance

It is noticed that the impedance of line ( $Z_L$  is proportional to the length (L, therefore to determine the length or is the problem, it is just necessary to know the impedance i.e. the image of the tension and running starting from the TC and transmitters TT.

The line with protected must be divided by three downstream zones and a upstream zone (Fig. 1).

- The 1st downstream zone; Cover approximately 80% with line protected AB and started the circuit breaker in  $T_1$ .
- The 2nd downstream zone. From 100% of the line protected AB extends + 20% from the adjacent line shortest and started the circuit breaker in  $T_2$ .
- The 3rd downstream zone; From 100% of the line protected AB extends + 40% from the adjacent line longest and started the circuit breaker in  $T_3$ .
- 4th zone; is a upstream zone of 60% of line protected AB and started the circuit breaker in  $T_4$ .

Times of release  $t_1$ ,  $t_2$ ,  $t_3$  and  $t_4$  correspond, respectively to these four zones of operation and different from a selective interval (chronometric selectivity).

The chronometric selectivity (Fig. 2) of protection is given by the spreading out of times of release according to the distance between point of measurement and the defect.

The protection of distance has a polygonal characteristic of release Fig. 3. According to the ordered model, it is possible to have a circular characteristic too.

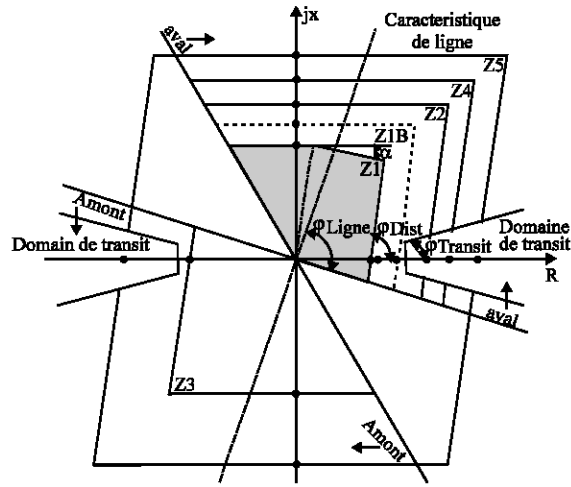

Fig. 3: Polygonal characteristic of a relay of distance

It is necessary particularly to announce the advantage offered by using the polygonal characteristics when it is a question of protecting the long and very charged lines.

Various types of relay of distance measurement of used in the world are (Edmund and Roberts, 1993).

**Electromechanical relays:** These relays are based on the principle of a disc of induction actuated by reels supplied with electric variables of the network via transformers of current and tension. An adjustable return spring determines the limit of the action of the disc on a release (points of adjustment).

The electromechanical equipment is assemblies of functions: threshold detection and temporization. They had the advantage of being robust, of functioning without auxiliary source of energy and not to be very sensitive to the electromagnetic disturbances. These relays are dissociated by their solidity and their great reliability, for this reason, their maintenance is tiny. They are famous for their reliability in the most delicate environments of work. It is nevertheless desirable to control them regularly, whose checking interval depends on the operating conditions.

The disadvantages of these devices, which remain nevertheless largely met, are:

- The risk to be out of state to function between two periods of maintenance.
- Lack of precision, the device being sensitive to its environment and the phenomena of wear.
- It is also difficult to obtain adjustments adapted to the weak fault currents.
- Its manufacturing cost is raised.

- Insufficient performances and authorize employment only simple elementary functions, in a limited number and without redundancy, From these disadvantage. this type of protection tends to disappear at the present time.

Example: RXAP6235, PSW162, PAC410

**Static relays:** The development of electronics pushed protections towards the use of the discrete electronic components and the static relays. These protections, appeared on the market in the years 1970, are based on the principle of the transformation of electric variables of the network, provided by transformers of current and tension, in electric signals of weak voltage which are compared with values of reference (points of adjustment).

The circuits of comparison provide signals temporizations which actuate relays of exit to releases. These devices require a source of continuous auxiliary supply in general:

- They provide a good precision and allow the detection of the weak fault currents.
- Each unit operates like a unit function and several functions are necessary to fulfill a function of complete protection.

The disadvantages of these devices remain:

- The risk to be out of state to function between 2 periods of tests.
- Great consumption in day before.
- The weak operational safety (not of function of self-checking).

Example: PDS 2000, LZ96A,, PAKS

**The numerical relays:** Numerical technology made its appearance at the beginning of the years 1980. With the development of the microprocessors and memories, the numerical chips were integrated into the protection equipments (Sidhu *et al.*, 2000).

Numerical protections are based on the principle of the transformation of electric variables of the network, provided by transmitters, in signals numerical of low voltage. The use of numerical techniques of treatment of the signal allows composing the signal in vectors what authorizes a processing of data via algorithms of protection according to protection desired. Moreover, they are equipped with liquid crystal display on the front face for local operation.

These devices require an auxiliary source; offer an excellent level of precision and a high level of sensibility, they provide new possibilities, like:

- Integration of several functions to fulfill a function of protection supplements in same links.
- Processing and the storage of data.
- The recording of the disturbances of the network (perturbograph).
- The diagnosis of the connected devices (circuit breakers... etc.).

These models integrate possibilities of auto test and self-checking which increases their continuity of operation while reducing the duration and the frequency of the maintenance actions. In addition to the functions of protection, these equipments lay out complementary functions facilitating their operation. The series connections allow the setting of the parameters from a microcomputer and to connect them to a system of control the local level and central level. They also allow benefiting from the recent discoveries in the field of artificial intelligence, like fuzzy logic.

Example: 7SA 511, 7SA 612, D60, REL 314... etc

The functions of protection Fig. 4 are fulfilled by multifunction relays or apparatuses. At the origin, the relays of protection were of analogical type and generally carried out only one function. Currently, numerical technology is more employed. It makes it possible to conceive increasingly advanced functions and the same apparatus generally fulfils several functions. This is why; one speaks rather about multifunction apparatuses.

**SIPROTEC 7 SA 612:** SIPROTEC 7SA612 is a relay of remote protection for energy transmission lines. These relay ensures all the range of distance protection and has the whole functions of protection normally necessary to the protection of a power line.

The relay is used for the fast and selective release of defects in the span and transmission cables and the air lines with or without compensation lines of series condensers. The neutral point of the network can be solid or put at the ground (resistance against ground), put at the ground by inductive way via Peterson reel or insulated. It is adapted for the applications to release single-phase current and three-phase current with and without curves of remote protection.

The numerical protection of distance SIPROTEC 7SA612 is equipped with a powerful microprocessor-

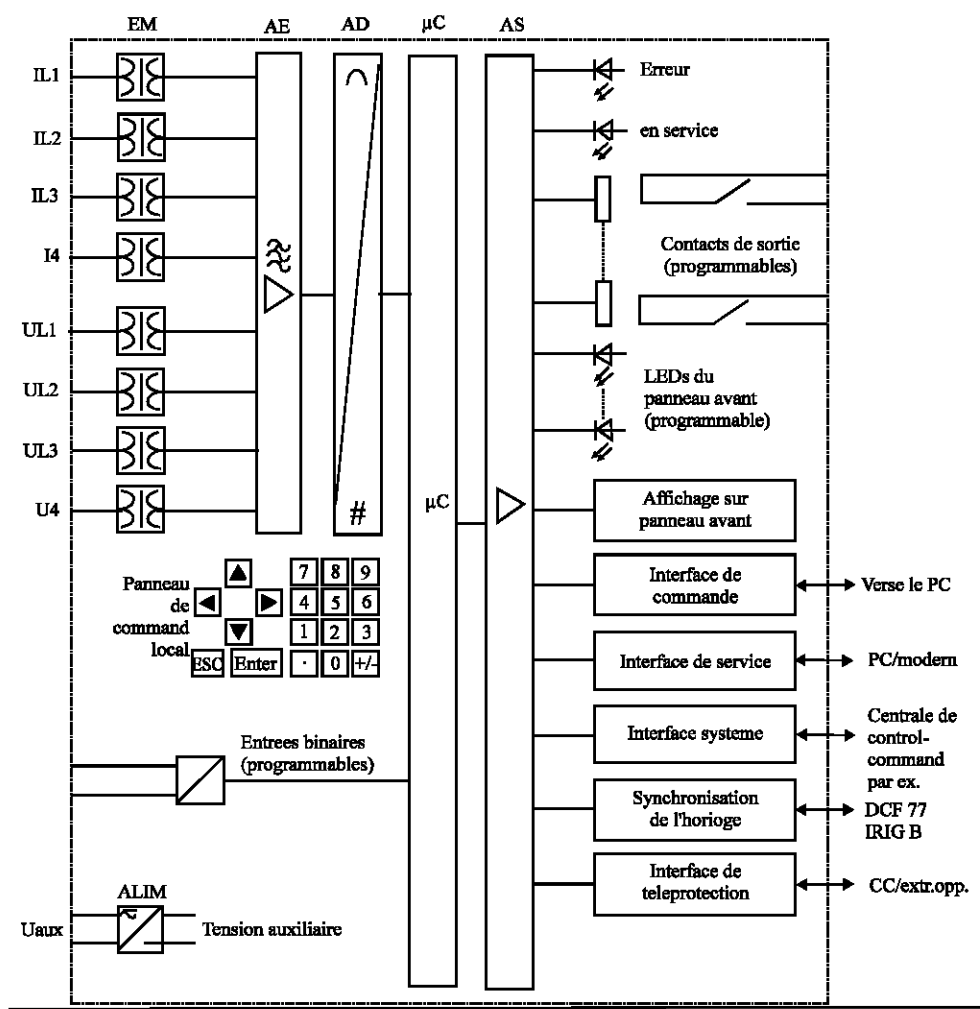

Fig. 4: Structure of the numerical protection of distance 7SA612

based system. All the operations carried out by this apparatus, such as the acquisition of the values of measurement and the emission of the orders intended for the circuit breakers and other equipment high voltage are treated in a completely numerical way.

The entries of measurement EM transform the currents and tensions from the reducers from associated current and tension and convert them according to the suitable levels of amplitude for the internal treatment of the apparatus. This apparatus has 4 wires entries of currents and 4 entries of tension. The 3 wires entries of currents are planned for the acquisition of the currents of phase, a fourth (I4) can be configured for the ground current (not neutral of the reducer of current), for the ground current of a parallel line (compensation of parallel line) or for the measurement of the current crossing the neutral point of a transformer source (for determination of direction of the defects ground).

### MATHEMATICAL MODEL OF THE STUDIED LINE

It is a question of ensuring an adequate and effective protection of a decentralized Production connected to a play of an HVB 220 kV. This protection Fig. 5 is based on a dialogue between 2 protections remotely numerical; equipped each one with its reeclenchor 7SA612 (of family 7SA of Siemens). In order to mitigate no rare operations, but nevertheless exist

**Purpose of two protections:** Protections of numerical distance are intended to ensure the selectivity of the networks neutral connected directly to the ground. These protections offer characteristics especially adapted to the lines of any type long, average or short, a fast time of release whatever the position of the defect compared to the limit of supervised distance.

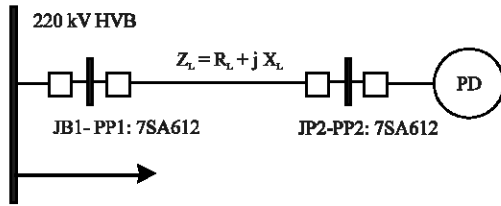

Fig. 5: Model of the studied line: In decentralized production connected to bus 220 kV HVB

**Given studied line:**

Nominal voltage:  $U = 220$  kV (phase-phase)  
 Frequency rated:  $f = 50$  Hz  
 Length of the line:  $L = 100$  km

Resistance of the hot line  $R_1 = 0,12 \Omega \text{ km}^{-1}$ ,  
 Resistance of the opposite line  $R_2 = 0,12 \Omega \text{ km}^{-1}$ .  
 Resistance of the homopolar line  $R_0 = 3 R_1$ .  
 Reactance of the hot line  $X_1 = L\Omega = 0.42 \Omega \text{ km}^{-1}$ .  
 Reactance of the opposite line  $X_2 = L\Omega = 0.42 \Omega \text{ km}^{-1}$ .  
 Reactance of the homopolar line  $X_0 = 3 * X_1 \Omega \text{ km}^{-1}$ .

Capacitive reactance of the line:  $1/cw$  is neglected because the line is average length.

Impedance of the line:  $Z_L = R_L + j X_L = 0.12 + j 0.42 \Omega \text{ km}^{-1}$ .  
 Modulate  $Z_L = 0,43680$ .  
 The angle of the line  $\vartheta_L = \text{Arc tg} (X/R) = 74.0546^\circ$

The section of driver:  $S = 256 \text{ mm}^2$   
 Type of driver of the line is ALMELEC

Resistance of pylon:  $R_{pyl} = 25 \Omega$   
 Resistance of arc:  $R_{arc} = 6 \Omega$  for the defects phase-phase  
 Resistance of arc:  $R_{arc} = 9 \Omega$  for the defects phase - ground  
 For these resistance  $R_{arc}$  and  $R_{pyl}$  they are measured been worth.

**Given to transform of measurement:**

$K_{TT} = 220 \text{ 000V} // 100V / = 2200$   
 $K_{TC} = 1600 \text{ A} / 1 \text{ A} = 1600$   
 $K_Z = K_{TT} / K_{TC} = 2200 / 1600 = 1,3750$   
 Factors of ground complexes impedance  $K_0 = 1/3 [ (Z_0 / Z_1 - 1) ] = 0,6666$

**Determination of the various zones of measurements:**

$X_{HT} = X * L = 0.42 * 100 = 42 \Omega$   
 $R_{HT} = R * L = 0.12 * 100 = 12 \Omega$

$$X_{BT} = X_{HT} / K_Z = 42 / 1.375 = 30.5454 \Omega$$

$$R_{BT} = R_{HT} / K_Z = 12 / 1,375 = 8,7272 \Omega$$

**1st zone of measurement swallows some (80% of the line with protected):**

$$Z_1 = 80\% * Z = R_1 + jX_1$$

$$X_1 = X_{BT} * 80\% = 30.5454 * 0.80 = 24.4363 \Omega$$

$$R_1 = R_{BT} * 80\% = (8.7272 * 0,80) + 6 = 12.9817 \Omega$$

$$R_{1E} = (R_{BT} * 80\%) + R_{arc} + R_{pyl} = (8.7272 * 0.80) + 9 + 25 = 40.9817 \Omega$$

- Time of release of the circuit breaker is with  $T = 0$  S. (Instantaneous)

**2nd zone of measurement in downstream (120% of the line with protected):**

$$Z_2 = 1200\% * Z = R_2 + jX_2$$

$$X_2 = X_{BT} * 120\% = 30.5454 * 1.20 = 36.6544 \Omega$$

$$R_2 = R_{BT} * 120\% = (8.7272 * 1.20) + 6 = 16.4726 \Omega$$

$$R_{2nd} = (R_{BT} * 120\%) + R_{arc} + R_{pyl} = (8.7272 * 1.20) + 9 + 25 = 44.4726 \Omega$$

- Time of release of the circuit breaker is with  $T = 0,3$  S.

**3rd zone of measurement in downstream (140% of the line with protected):**

$$Z_3 = 140\% * Z = R_3 + jX_3$$

$$X_3 = X_{BT} * 140\% = 30.5454 * 1.40 = 42.7635 \Omega$$

$$R_3 = R_{BT} * 140\% = (8.7272 * 1.40) + 6 = 18.2180 \Omega$$

$$R_{3rd} = (R_{BT} * 140\%) + R_{arc} + R_{pyl} = (8.7272 * 1.40) + 9 + 25 = 46.2180 \Omega$$

-Time of release of the circuit breaker is with  $T = 1,5$  S.

**4th zone of measurement upstream (60% of the line with protected):**

$$Z_4 = 60\% * Z = R_4 + jX_4$$

$$X_4 = X_{BT} * 60\% = 30.5454 * 0.60 = 18.3272 \Omega$$

$$R_4 = R_{BT} * 60\% = (8.7272 * 0.60) + 6 = 11.2363 \Omega$$

$$R_{4th} = (R_{BT} * 60\%) + R_{arc} + R_{pyl} = (8.7272 * 0.60) + 9 + 25 = 39.2363 \Omega$$

- Time release of circuit breaker is to  $T = 2,5$  S.

**The zone of starting (started):**

$X + A$  (reactance of starting downstream)  
 $X + A = X_{BT} * 140\% = 30.5454 * 1.40 = 42.7635 \Omega$   
 $X - A$  (reactance of starting upstream)  
 $X - A = X_{BT} * 60\% = 30.5454 * 0.60 = 18.3272 \Omega$

Table 1: Programming of the zones of measurements of the 7SA612

	1st zone	2nd zone	3rd zone	4th zone
Resistance (Ω)	12.4363	16.4726	18.2180	11.2363
Reactance (Ω)	24.9817	36.6544	42.7635	18.3272
Resistance				
Phase-earth (Ω)	40.9817	44.4726	46.2180	39.2363
Temporisation (s)	0	0.3	1.5	2.5

**Programming of the zones of measurements:** Calculate zones of measurements previously fact are summarize in the Table 1:

**TESTS AND RESULTS OF SIMULATION**

**Used equipment:** The tests are carried out with the assistance of:

- The case of injection CMC256 of OMICRON.
- Microcomputer (PC).
- Two numerical protections of distance (7SA612).

The standard case of injection (CMC 256) manufacturer OMICRON, the CMC 256 fact part of a system of test, it is designed for test apparatuses of protection and measurement, in the public services as in the manufacturers; It is controlled by microcomputer, makes it possible to control operation, the characteristics of start-up and the release of the various safety devices.

CMC 256 offer a total flexibility and an adaptability for the various applications of tests.

**Components of the system:**

- CMC 256 with electric cable (sector),
- Connecting cable CMC 256 with PC (provided),
- Connecting cable CMC 256 with the equipment to be tested.

These tests were carried out on two types of defect in the zone N°1 starting from the play of bar JB1; (three-phase defect symmetrical and two-phase insulated);

To be able to program and communicate with protection 7SA612 one uses software DIGSI 4.7 of SIEMENS (is a graphic tool to manage components within systems SIEMENS the protection) Thereafter software SIGRA 4 assists you to exploit the recordings of defects.

On the basis of measured value and deposited in the recording of defects, SIGRA 4 calculates other values such as the direct impedances, the actual values, etc.

With the binary digits, these values of measurement and calculation are represented in graphic form and are gathered with the choice on following postings:

- Signals according to time.
- Images of pointer.

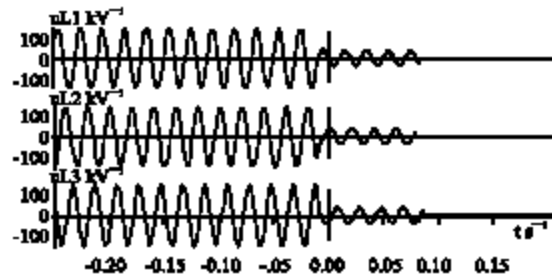

Fig. 6a: Phase ground tensions in the 3 phases of the line

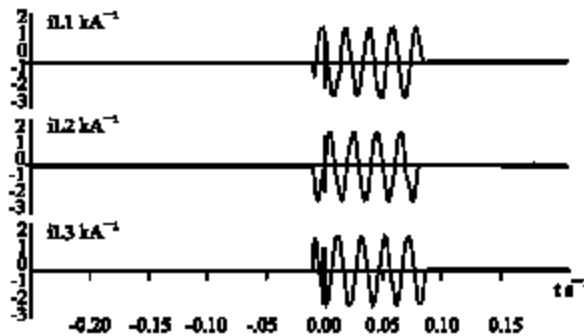

Fig. 6b: Currents in the 3 phases of the line

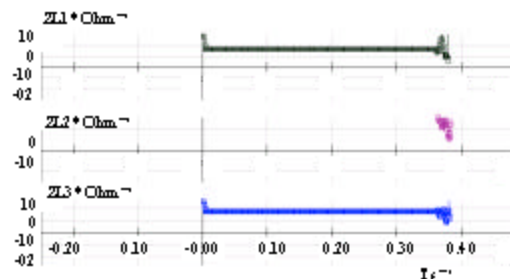

Fig. 6c: Variation of impedance Z in the phases

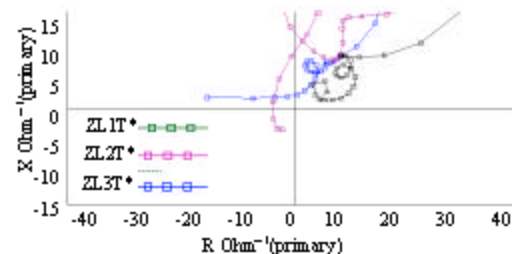

Fig. 6d: Variation of X according to R of the impedance phase ground of the line

- Loci.
- Harmonics.
- Localization of defect.



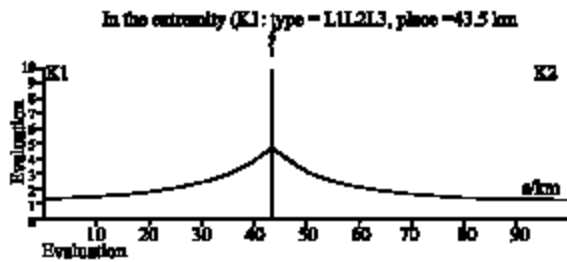

Fig. 6e: Localization of defect

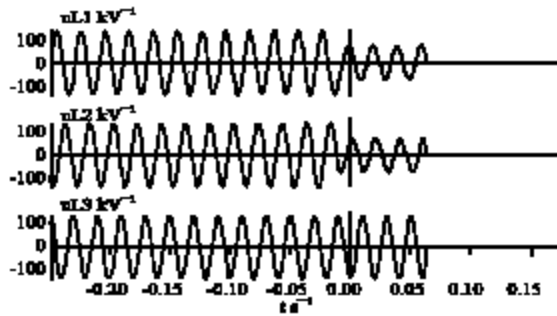

Fig. 7a: Phase ground tensions in the 3 phases of the line

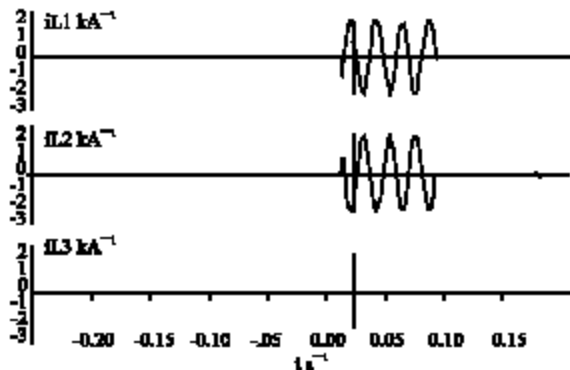

Fig. 7b: Currents in the 3 phases of the line

**We inject a three-phase symmetrical fault:** The Fig. 6a and 6b represent the phase ground, as well as the three phase line currents, these tensions are null at 0.08 sec. it is the time of final release of the three circuit breakers

Fig. 6c and d one notices a variation of reactance (X) according to resistance (R) in the three phases due to the defect that y is injected symmetrical three-phase type (most severe).

The distance between the JB1 and the point of defect is equal 43.5 km is represented in Fig. 6e.

**We inject a two-phase isolated fault (between phase 1 and 2) with  $Z_g = 0$ :** The Fig. 7a and b represent the phase ground tensions, as well as the three phase line currents, these tensions are null at 0,08 sec it is the time of final

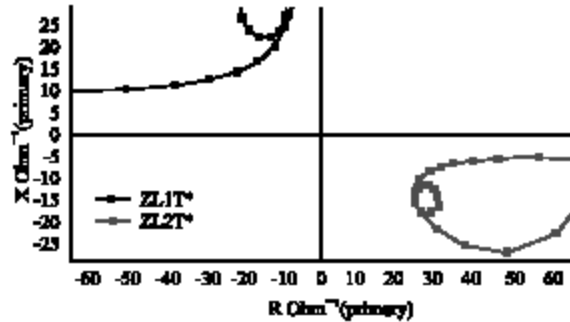

Fig. 7c: Variation  $g \times$  according to R

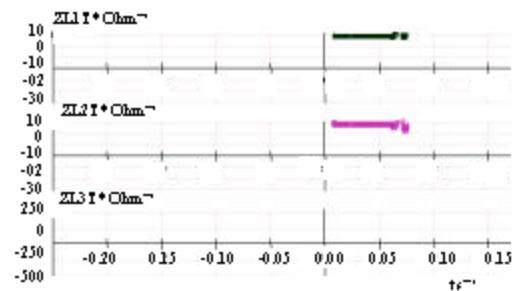

Fig. 7d: Variation g impedance in the phase

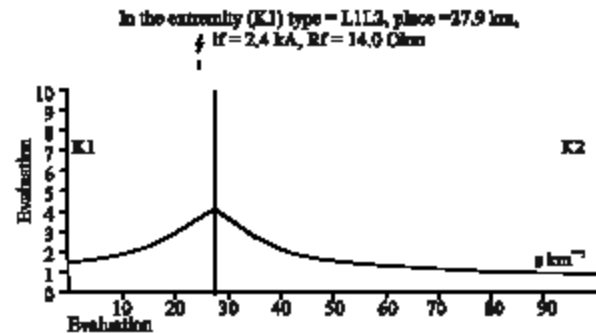

Fig. 7e: Localization of defect

release of the three circuit breakers because the type of defect which was simulated, is an implicitly isolated 2-phase defect, final release of the 3 circuit breakers.

Figure 6c and d one notices a variation of reactance (X) according to resistance (R) in the 2 phases in short circuit (phase 1 and 2).

The distance between the JB1 and the point of defect is equal 27.9 km is represented in the Fig. 7e.

### CONCLUSION

The definition of the protection system which a Producer must deploy to be erased under the best conditions in the event of defect of insulation assigning the work of connection to HVB network requires a very

detailed attention. It must always be carried out while having with precondition clearly identified the responsibilities for the various actors (exploiting works networks, owner of the work of production).

The knowledge of the mode of connection to HVB network is determining to proceed to the study of the system protection and it can happen that a preliminary study of this one results in adjusting the technical conditions of connection, the feasibility of the required protection system being able to require it.

The optimization of the protection system must be done on the basis of expression of the needs explicit and clear and can have an impact on the project as regards definition of HVB installations (measurements reducing) to envisage.

The choices to be made concerning the systems design must be compatible with the future provisions of exploitation which will be the "producing" subject of the instruction.

In the study which we have to undertake, the protection of distance based on the dialogue of two protections using the numerical technology of relay 7SA612: Constitute a powerful means in term of speed and selectivity for the elimination of the line defects and station bars of connection, it can ensure a "distant " help under good conditions.

## REFERENCES

- Edmund, O.S. and J. Roberts, 1993. Distance relay element design. In: 64th Annual Conference for Protective Relay Engineers.
- El-Arroudi, K., G. Joos and D.T. McGillis, 2002. Operation of impedance protection relays with the STATCOM IEEE. *Trans. Power Delivery*, 17 (2): 381-387.
- Labeled, D., 2006a. Production Décentralisée et couplage au réseau de Production Décentralisée au Réseau. *Seconde Conférence Internationale sur le génie électrique CIGE Bechar*.
- Labeled, D., 2006b. Contraintes Techniques liées au Raccordement de Production Décentralisée au Réseau. *Colloque national sur l'énergie solaire. CNESOL Bejaia*.
- Samantaray, S.R., P.K. Dash, G. Panda and B.K. Panigrahi, 2005. Distance protection of compensated transmission line using computational intelligence. *Published Lecture Notes Comput. Sci.*, 3801: 163-169.
- Sidhu, T.S., D.S. Ghotra and M.S. Sachdev, 2000. A Fast Distance Relay Using Adaptive Data Window Filters. *IEEE/PES Summer Meeting*, pp: 1407-1412.